

UNMARKED TOLERANCES	
SIZE	TOLERANCE
<4	±0.2
4~8	±0.25
8~16	±0.3
16~32	±0.4
32~63	±0.5

REV	DESCRIPTION	DATE	APPROVED
S0	CREATED DRAWING	2024/03/22	ZK
S1	CREATED DRAWING	2025/07/20	GZQ
S2	CREATED DRAWING	2025/07/28	GZQ

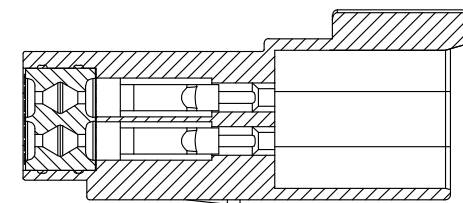
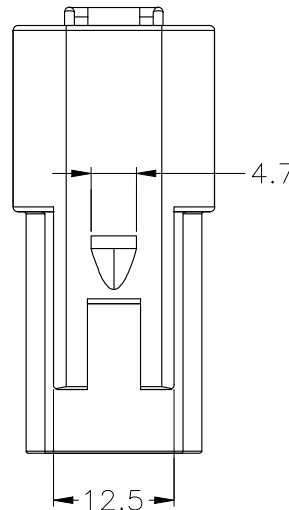
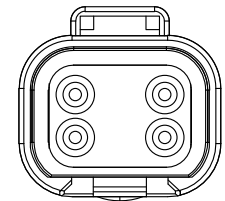
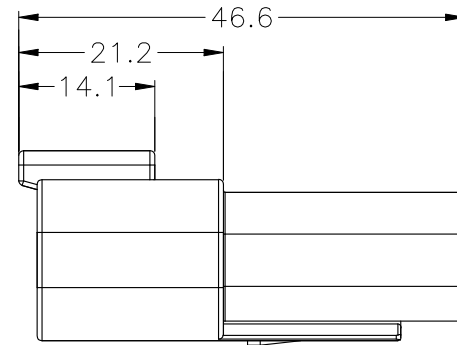
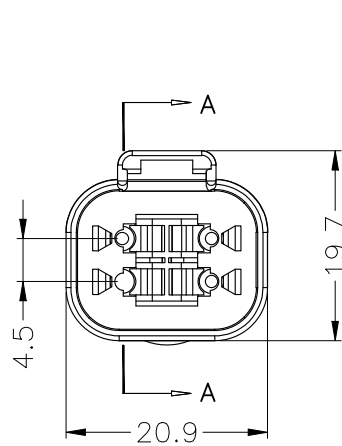

SEC A-A

Detailed Product Description:
Products comply with SKGY0013-2005

- 1.Smooth surface, no burrs, cracks and other defects
- 2.Mechanical characteristics: mating/cycle >50cycle
- 3.Operating temperature: -40°C ~ +85°C

Other Specification

Insulation plastic: PA66+15%GF
Internal plug-ins: PA66+15%GF
Waterproof rubber plug: Silicone
Packing:PE Bag

Color: Gray
Color: Green
Color: Dark Red

*ALL MATERIALS ARE RoHS COMPLIANT.

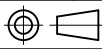
 SIGNAL [®] ShenZhen Signal Electronics co.,Ltd		TITLE SDT04-4P CONNECTOR HOUSING	
		SGN NO YDHS0445	REV. S2
DRAWN BY	DATE	DWG NO	CUSTOMER
CHECKED BY	DATE		
CHECKED BY	DATE		
APPROVED BY	DATE		
<small>THE INFORMATION CONTAINED IN THIS DRAWING IS THE SOLE PROPERTY OF SIGNAL COMPANY. ANY REPRODUCTION IN PART OR WHOLE WITHOUT THE WRITTEN PERMISSION OF SIGNAL COMPANY IS PROHIBITED.</small>		TOLERANCES ARE: DECIMALES ANGLES x.' ±2.0' .x' ±1.0'	THIRD ANGLE PROJECTION  SIZE: A4 UNITS: mm SCALE: 1:1 SHEET: 1 OF 1